

Solenoid valve for gas VAS 6–9, double solenoid valve VCS 6–9

OPERATING INSTRUCTIONS

Cert. Version 07.19 · Edition 06.24 · EN · 03250580

1 SAFETY

1.1 Please read and keep in a safe place



Please read through these instructions carefully before installing or operating. Following the installation, pass the instructions on to the operator. This unit must be installed and commissioned in accordance with the regulations and standards in force. These instructions can also be found at www.docuthek.com.

1.2 Explanation of symbols

1, 2, 3, a, b, c = Action

→ = Instruction

1.3 Liability

We will not be held liable for damage resulting from non-observance of the instructions and non-compliant use.

1.4 Safety instructions

Information that is relevant for safety is indicated in the instructions as follows:



DANGER

Indicates potentially fatal situations.



WARNING

Indicates possible danger to life and limb.



CAUTION

Indicates possible material damage.

All interventions may only be carried out by qualified gas technicians. Electrical interventions may only be carried out by qualified electricians.

1.5 Conversion, spare parts

All technical changes are prohibited. Only use OEM spare parts.

2 CHECKING THE USAGE

Gas solenoid valves VAS for safeguarding gas or air on various appliances. Double solenoid valves VCS are combinations of two gas solenoid valves. This function is only guaranteed when used within the specified limits – see page 9 (12 Technical data). Any other use is considered as non-compliant.



CONTENTS

1 Safety	1
2 Checking the usage	1
3 Installation	2
4 Wiring	3
5 Tightness test	5
6 Commissioning	5
7 Replacing the solenoid actuator, replacing the actuator cartridge	5
8 Replacing the damping unit	5
9 Replacing the circuit board	5
10 Maintenance	5
11 Accessories	6
12 Technical data	9
13 Designed lifetime	11
14 Logistics	11
15 Certification	12
16 Pressure units	12

2.1 Type code

VAS	Solenoid valve for gas
VCS	Double solenoid valve
6-9	Sizes
65-125	Inlet and outlet flange nominal size
F	Flange to ISO 7005
05	p_u max. 500 mbar
N	Valve 1 quick opening, quick closing
L	Valve 1 slow opening, quick closing
L	Valve 2 slow opening, quick closing
N	Valve 2 quick opening, quick closing, with flow adjustment
W	Mains voltage 230 V AC, 50/60 Hz
Q	Mains voltage 120 V AC, 50/60 Hz
K	Mains voltage 24 V DC
G	With POC/CPS for 24 V and visual position indicator
S	With POC/CPS and visual position indicator
L	Viewing side: left
R	Viewing side: right
3	Electrical connection: M20 cable gland
5	Electrical connection: plug without socket
6	Electrical connection: plug with socket
7	Electrical connection: plug for 2 valves and POC/CPS without socket
8	Electrical connection: plug for 2 valves and POC/CPS with socket
B	Basic
E	Prepared for adapter plates
P	Accessory, right, inlet: screw plug
M	Accessory, right, inlet: pressure test point
1-4	Accessories, right, inlet: pressure switch DG..VC
P	Accessory, right, interspace 1: screw plug
M	Accessory, right, interspace 1: pressure test point
1-4	Accessories, right, interspace 1: pressure switch DG..VC
P	Accessory, right, interspace 2: screw plug
M	Accessory, right, interspace 2: pressure test point
Z	Accessories, right, interspace 2: pilot gas valve VAS 1
B	Accessories, right, interspace 2: bypass valve VAS 1
E	Accessories, right, interspace 2: prepared for Rp 1 vent line
1-4	Accessories, right, interspace 2: pressure switch DG..VC
P	Accessory, right, outlet: screw plug
M	Accessory, right, outlet: pressure test point
1-4	Accessories, right, outlet: pressure switch DG..VC

The same accessories can be selected for the left- or right-hand side.

2.2 Part designations

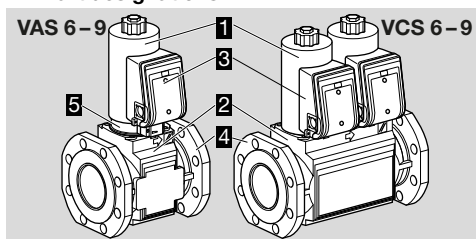

- 1 Solenoid actuator
- 2 Flow body
- 3 Connection box
- 4 Connection flange
- 5 Proof of closure switch

2.3 Type label

Mains voltage, electrical power consumption, ambient temperature, enclosure, inlet pressure and installation position: see type label.

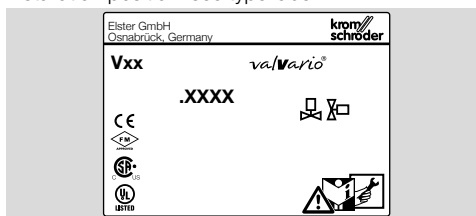

3 INSTALLATION

⚠ CAUTION

Incorrect installation

Please observe the following to ensure that the gas solenoid valve is not damaged during installation and operation:

- Sealing material and dirt, e.g. thread cuttings, must not be allowed to get into the valve housing.
- A filter must be installed upstream of every system.
- Dropping the device can cause permanent damage. In this event, replace the entire device and associated modules before use.
- Do not clamp the unit in a vice. Only secure the flange by holding the octagon with a suitable spanner. Risk of external leakage.
- Solenoid valves with overtravel switch and visual position indicator VAS/VCS..S or VAS/VCS..G: actuator cannot be rotated.

→ Install the unit in the pipe free of mechanical stress.

→ Installation position: black solenoid actuator in the vertical upright position or tilted up to the horizontal, not upside down. In humid environments: black solenoid ac-

tuator in the vertical upright position only.

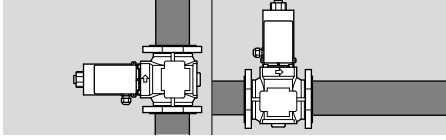

- The housing must not be in contact with masonry, minimum clearance 20 mm (0.79").
- Ensure that there is sufficient space for installation, adjustment and maintenance work. Minimum clearance of 50 cm (20") above the black solenoid actuator.

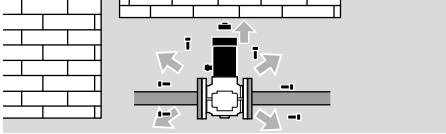

- Depending on the device type, the inlet pressure p_u , the interspace pressure p_z and the outlet pressure p_d can be measured using pressure test points, see accessories.

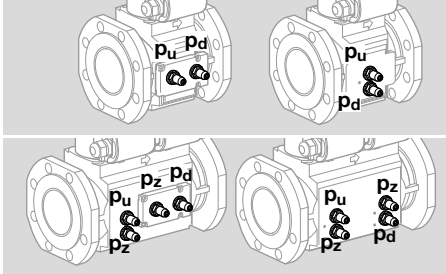

- 1 Remove the adhesive label or screw cap from the inlet and outlet flange.
- 2 Obey the direction of flow as marked on the housing.

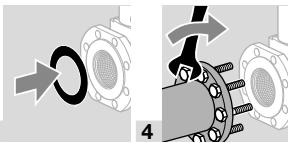

4 WIRING



WARNING

Risk of injury!

Please observe the following to ensure that no damage occurs:

- Electric shocks can be fatal! Before working on possible live components, ensure the unit is disconnected from the power supply.
- The solenoid actuator heats up during operation. Surface temperature approx. 85°C (approx. 185°F).

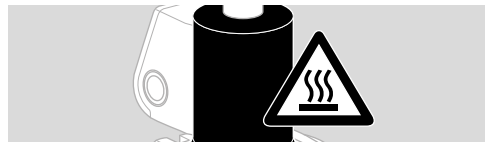

- Use temperature-resistant cable (> 90°C).
- 1 Disconnect the system from the electrical power supply.
- 2 Shut off the gas supply.
- Wiring to EN 60204-1.
- UL requirements for the NAFTA market. To maintain the UL environmental rating Type 2, the enclosure openings shall be closed with fittings rated UL Type 2; 3; 3R; 3RX; 3S; 3SX; 3X; 4X; 5; 6; 6P; 12; 12K or 13. Gas solenoid valves shall be protected by a branch circuit protective device not exceeding 15 A.

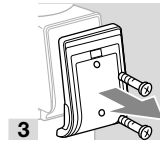

M20 cable gland

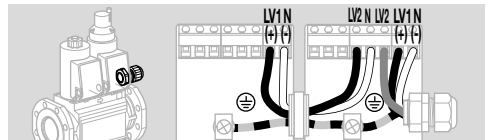
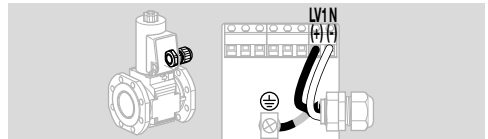
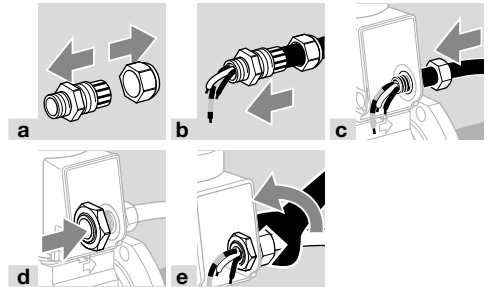

Plug

- 24 V DC: the valve does not open when the connections (+ and -) are reversed. When replacing VG..K with VAS..K/VCS..K, the plug must be rewired.

- LV1 (+) = black, LV2 (+) = brown, N (-) = blue

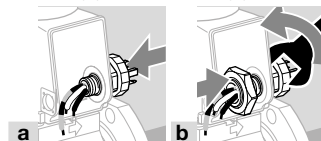

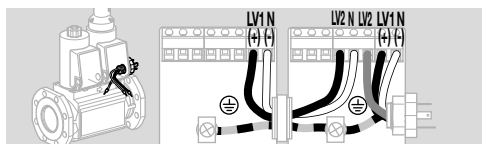
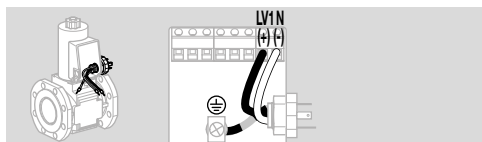

Socket

→ 1 = N (-), 2 = LV1 (+), 3 = LV2 (+)

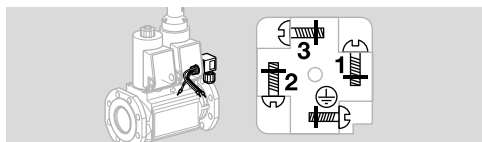
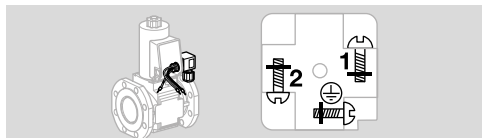
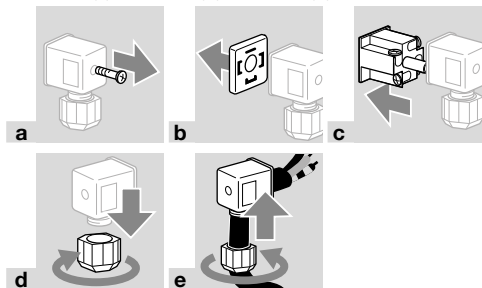

Proof of closure switch

→ VAS/VCS open: contacts **1** and **2** closed, VAS/VCS closed: contacts **1** and **3** closed.

→ Indicator of proof of closure switch: red = VAS/VCS open, white = VAS/VCS closed.

CAUTION

Please observe the following to ensure smooth operation:

- The proof of closure switch is not suitable for frequent cycling operation.
- Route valve and proof of closure switch cables separately through M20 cable glands or use two separate plugs. Otherwise, there is a risk of interference between valve voltage and proof of closure switch voltage.

→ Proof of closure switch: **1** = COM, **2** = NO, **3** = NC

Proof of closure switch and M20 cable gland:

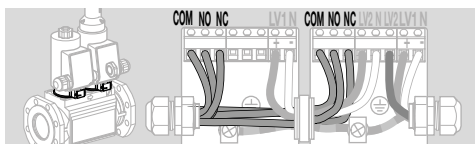
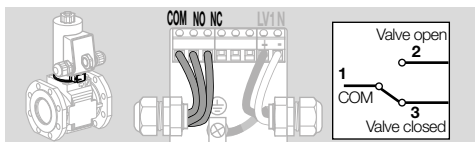

Proof of closure switch and plug:

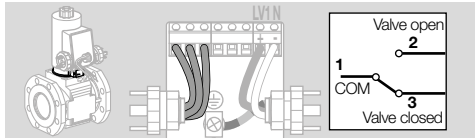

→ Double solenoid valve: if a plug with socket is fitted, only one proof of closure switch can be connected.

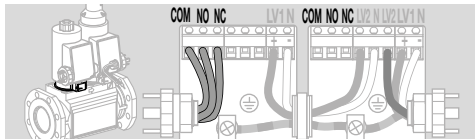

Proof of closure switch and socket:

→ When installing two plugs on a VAS with proof of closure switch: label the sockets and plugs to avoid confusion.

→ Proof of closure switch: **1** = COM, **2** = NO, **3** = NC

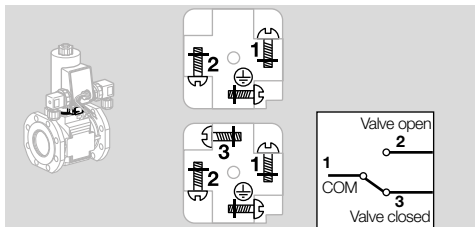

Finishing the wiring

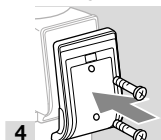

5 TIGHTNESS TEST

- 1 Close the gas solenoid valve.
- 2 To be able to check the tightness, shut off the downstream pipeline close to the valve.

$$N_2 \leq 1,5 \times p_{u \max}$$

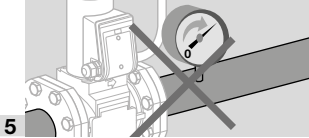
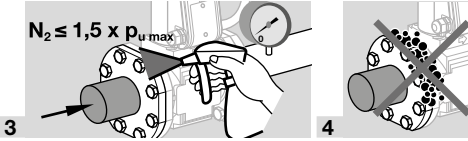

- 6 Open the solenoid valve.

$$N_2 \leq 1,5 \times p_{u \max}$$

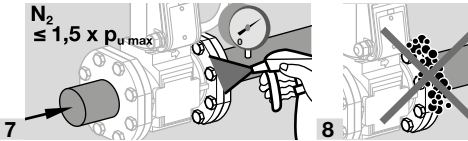

- 9 Tightness OK: open the pipeline.
 - Pipeline leaking: replace flat seal on flange. Then check for tightness once again.
 - Unit leaking: remove the unit and return it to the manufacturer.

6 COMMISSIONING

6.1 Setting the flow rate

- At the factory, the gas solenoid valve is adjusted for maximum flow rate Q.
- Allen key: 6 mm.

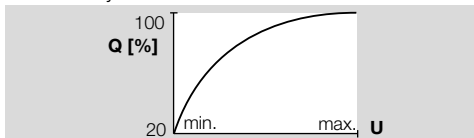

	Turns U min. – U max.
VAS 6, VCS 6	10
VAS 7, VCS 7	11.5
VAS 8, VCS 8	13

VAS 9, VCS 9 has no restrictor and damping function

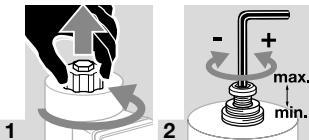

- 3 Screw the cap back on tight in order to prevent the actuator from being rotated.

6.2 Setting the start gas rate

VAS..L, VCS..L

- The start gas rate can be set by turning the damping unit a maximum of 3 turns.
- There must be a period of 20 seconds between switching the valve off and on again so that the damping is fully effective.
- Use a 3 mm Allen key.
- Undo the screw at the “V Start” mark by approx. 1 mm, but do not unscrew completely.

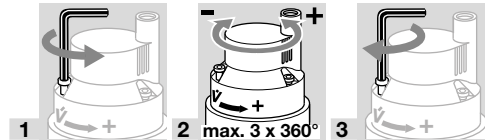

7 REPLACING THE SOLENOID ACTUATOR, REPLACING THE ACTUATOR CARTRIDGE

See operating instructions enclosed with spare part or see www.docuthek.com.
A web app for selecting the correct spare part is available at www.adlatus.org.

8 REPLACING THE DAMPING UNIT

See operating instructions enclosed with spare part or see www.docuthek.com.
A web app for selecting the correct spare part is available at www.adlatus.org.

9 REPLACING THE CIRCUIT BOARD

See operating instructions enclosed with spare part or see www.docuthek.com.
A web app for selecting the correct spare part is available at www.adlatus.org.

10 MAINTENANCE

⚠ CAUTION

In order to ensure smooth operation, check the tightness and function of the unit:

- Once per year, twice per year in the case of biogas; check for internal and external tightness, see page 5 (5 Tightness test).
- Check electrical installations once a year in line with local regulations; pay particular attention to the PE wire, see page 3 (4 Wiring).

- If the flow rate has dropped, clean the strainer.

- 1 Disconnect the system from the electrical power supply.
- 2 Shut off the gas supply.

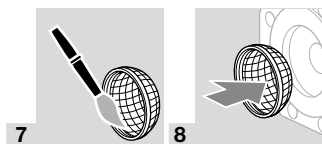
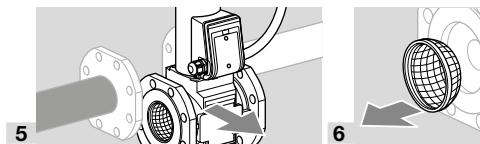
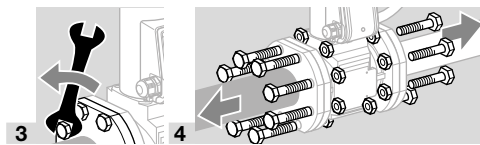

→ We recommend replacing the flat seals.

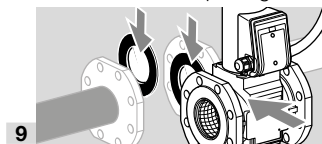

10 Once the flat seals have been replaced, install the unit in the pipeline.

11 Then check the unit for internal and external tightness, see page 5 (5 Tightness test).

11 ACCESSORIES

11.1 Pressure test nipples

Test nipples to check the inlet pressure p_u , interspace pressure p_z and outlet pressure p_d .

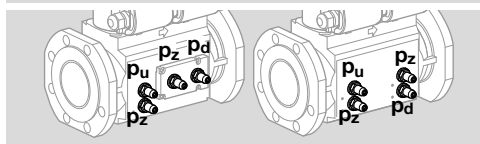
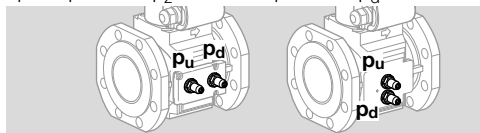

Scope of delivery

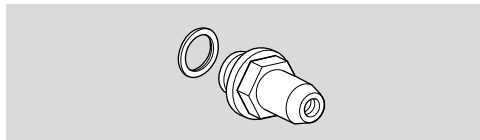

1 x test nipple with 1 x profiled sealing ring.

Rp ¼: Order No. 74923390,

¼ NPT: Order No. 74921869.

11.2 Pressure switch for gas DG..VC for VAS 6-9/VCS 6-9

The pressure switch for gas monitors the inlet pressure p_u , the outlet pressure p_d and the interspace pressure p_z .

→ Monitoring the inlet pressure p_u : the pressure switch for gas is mounted on the inlet side.
Monitoring the outlet pressure p_d : the pressure switch for gas is mounted on the outlet side.

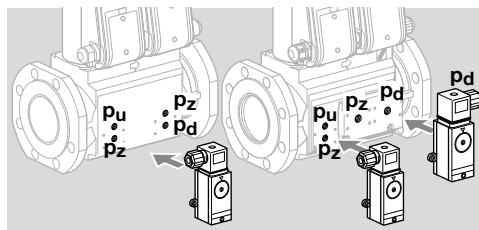
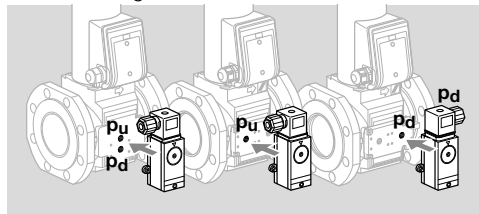

Scope of delivery:

- 1 x pressure switch for gas,
- 2 x self-tapping retaining screws,
- 2 x sealing rings.

Also available with gold-plated contacts for voltages of 5 to 250 V.

→ When retrofitting the pressure switch for gas, see enclosed operating instructions “Pressure switches for gas DG..C”, section entitled “Mounting the DG..C. on valVario gas solenoid valves”.

→ The switching point is adjustable via hand wheel.

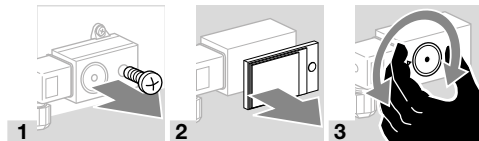

Type	Adjusting range (adjusting tolerance = ± 15% of the scale value)		Mean switching differential at min. and max. setting	
	[mbar]	[°WC]	[mbar]	[°WC]
DG 17VC	2-17	0.8-6.8	0.7-1.7	0.3-0.8
DG 40VC	5-40	2-16	1-2	0.4-1
DG 110VC	30-110	12-44	3-8	0.8-3.2
DG 300VC	100-300	40-120	6-15	2.4-8

→ Deviation from the switching point during testing pursuant to EN 1854 Gas pressure switches: ± 15%.

11.3 Tightness control TC 1V

- 1 Disconnect the system from the electrical power supply.
- 2 Shut off the gas supply.
 - The solenoid actuator cannot be rotated on solenoid valves with proof of closure switch VCx..S or VCx..G.
 - Connect the TC to the inlet pressure connection p_u and the interspace pressure connection p_z of the inlet valve. Ensure that connections p_u and p_z on the TC and the gas solenoid valve are not reversed.
 - TC and bypass/pilot gas valve cannot be fitted together on the same side of the double block valve.
 - In the case of a VCx combination, it is recommended to always install the bypass/pilot gas valve on the rear of the second valve and the tightness control on the viewing side of the first valve, together with the connection box.
 - The TC is secured using two captive combination Torx T20 screws (M4) inside the housing. Do not undo any other screws!

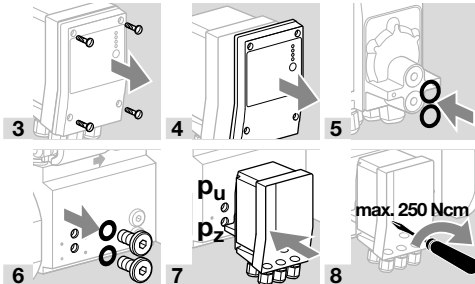
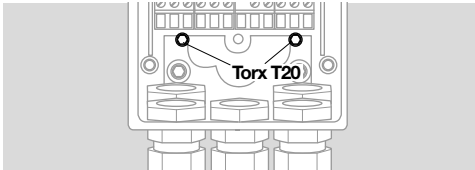

- For more information on wiring, testing the tightness and commissioning, see enclosed "Tightness control TC 1, TC 2, TC 3" operating instructions.
- 9 After completing the wiring, tightness test and commissioning for the TC, refit the housing cover on the TC.

11.4 Measuring adapter

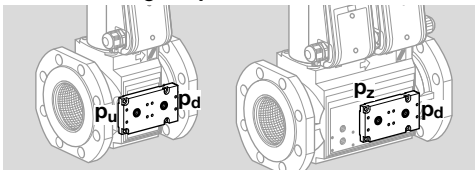

For the connection of the pressure switch DG..C, with a screw plug or pressure test nipple. VAS/VCS 6–9, Order No. 74923021, VAS..T/VCS..T 6–9, Order No. 74923022.

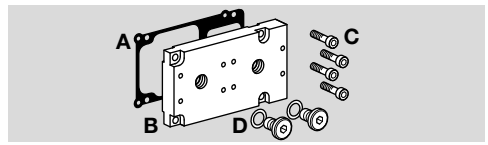

Scope of delivery:

- A 1 x seal,
- B 1 x measuring plate,
- C 4 x M5 set screws,
- D 2 x screw plugs with sealing rings.

11.5 Relief line adapter

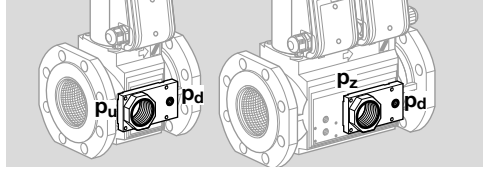

For the connection of a relief line (1½ NPT, Rp 1), with a screw plug or pressure test nipple. Rp 1, VAS/VCS 6–9, Order No. 74923025, 1½ NPT, VAS..T/VCS..T 6–9, Order No. 74923024.

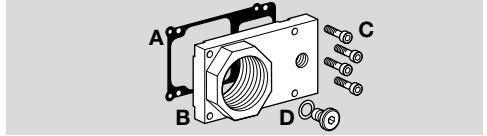

Scope of delivery:

- A 1 x seal,
- B 1 x Z flange,
- C 4 x M5 set screws,
- D 1 x screw plug with sealing ring

11.5.1 Installing the relief line adapter

- 1 Disconnect the system from the electrical power supply.
- 2 Shut off the gas supply.

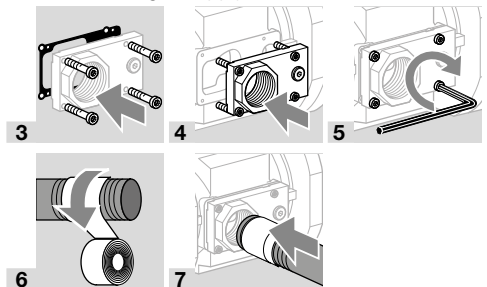

- 8 Shut off the downstream gas pipeline close to the valve.

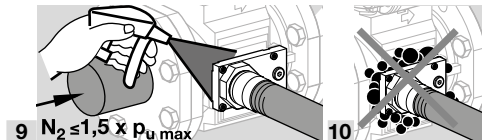

- 9 $N_2 \leq 1,5 \times p_{u \max}$
- 10 Tightness OK: open the pipeline.
 - Connection leaking: check seal.

11.6 Bypass adapter

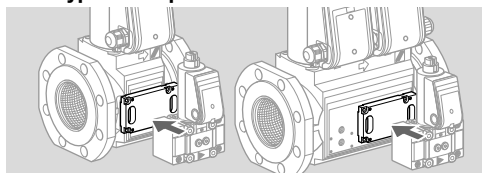

For connecting the bypass/pilot gas valve VAS 1.
Order No. 74923023

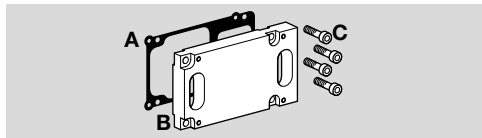

Scope of delivery:

- A 1 x seal,
- B 1 x bypass plate,
- C 4 x M5 set screws.

11.7 Replacing the adapter plate

- 1 Disconnect the system from the electrical power supply.
 - 2 Shut off the gas supply.
- We also recommend replacing the seal when replacing the adapter plate.

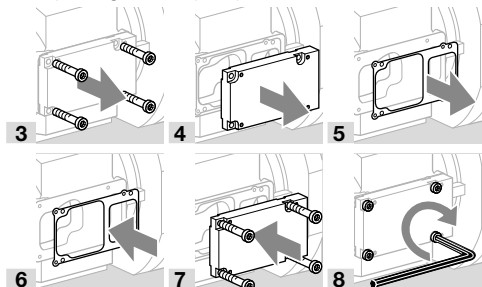

- Attached the required accessories, e.g. gas pressure switch or pressure test points, as described.
- If a bypass/pilot gas valve is to be installed, please continue reading as of point 1 in the following section entitled "Bypass/pilot gas valve".
- To be able to check the tightness, shut off the downstream pipeline as close as possible to the main valve.

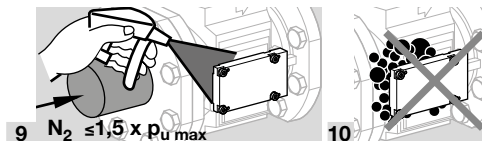

- 9 $N_2 \leq 1,5 \times p_{u \max}$
- 11 Tightness OK: open the pipeline.

→ Connection leaking: check seal.

11.8 Bypass/pilot gas valve

11.8.1 Scope of delivery of VAS 1 for VAS 6–9, VCS 6–9

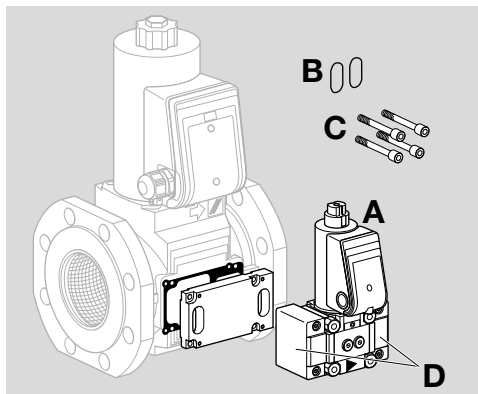

- A 1 x bypass or pilot gas valve VAS 1,
 - B 2 x flange O-rings,
 - C 4 x connecting screws.
- Bypass valve VAS 1:
D 2 x adapter flanges.
- Pilot gas valve VAS 1:
D 1 x adapter flange,
1 x adapter flange with threaded hole.

For connection to VAS 6–9, VCS 6–9, the adapter plate must be ordered separately, see page 8 (11.6 Bypass adapter).

11.9 Mounting the bypass/pilot gas valve to VAS 6–9

- 1 Disconnect the system from the electrical power supply.
- 2 Shut off the gas supply.

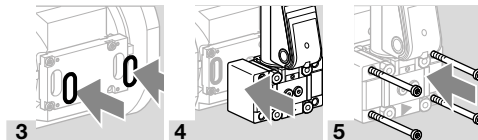

11.10 Checking the bypass/pilot gas valve for tightness at the inlet and outlet

- 1 To be able to check the tightness, shut off the downstream pipeline as close as possible to the main valve.
- The bypass/pilot gas valve must be closed.

Bypass valve

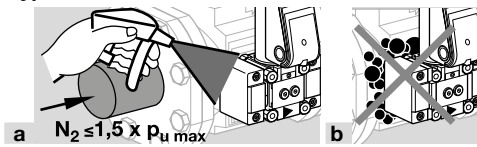

a $N_2 \leq 1,5 \times p_u \text{ max}$

b

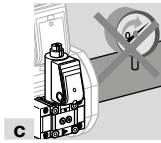

c

d Open the bypass valve.

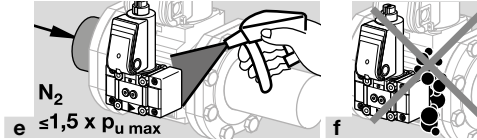

e $N_2 \leq 1,5 \times p_u \text{ max}$

f

Pilot gas valve

a **Pilot gas valve:** at the outlet, shut off the downstream pipeline close to the pilot gas valve.

b **VCS:** open the first VCS valve.

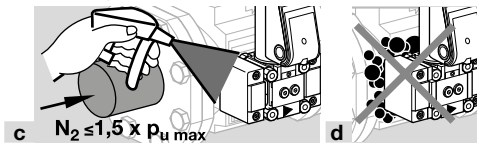

c $N_2 \leq 1,5 \times p_u \text{ max}$

d

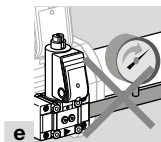

e

f Open the pilot gas valve.

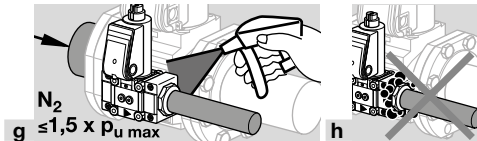

g $N_2 \leq 1,5 \times p_u \text{ max}$

h

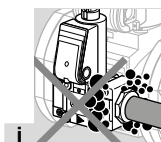

i

2 Tightness OK: open the pipeline.

→ Connection leaking: check the sealing rings.

→ Unit leaking: remove the valve and return it to the manufacturer.

12 TECHNICAL DATA

12.1 Ambient conditions

Icing, condensation and dew in and on the unit are not permitted.

Avoid direct sunlight or radiation from red-hot surfaces on the unit. Note the maximum medium and ambient temperatures!

Avoid corrosive influences, e.g. salty ambient air or SO_2 .

The unit may only be stored/installed in enclosed rooms/buildings.

The unit is suitable for a maximum installation height of 2000 m AMSL.

Ambient temperature: -20 to $+60^\circ\text{C}$ (-4 to $+140^\circ\text{F}$), no condensation permitted.

Long-term use in the upper ambient temperature range accelerates the ageing of the elastomer materials and reduces the service life (please contact manufacturer).

Storage temperature = transport temperature: -20 to $+40^\circ\text{C}$ (-4 to $+104^\circ\text{F}$).

Enclosure: IP 65 (NEMA 4).

This unit is not suitable for cleaning with a high-pressure cleaner and/or cleaning products.

12.2 Mechanical data

Gas types: natural gas, LPG (gaseous), biogas (max. 0.1 %-by-vol. H_2S), hydrogen or clean air; other types of gas on request. The gas must be clean and dry in all temperature conditions and must not contain condensate.

Medium temperature = ambient temperature.

CE and FM approved, UL listed, max. inlet pressure p_u : 500 mbar (7.25 psig).

FM approved, non operational pressure: 700 mbar (10 psig).

ANSI/CSA approved: 350 mbar (5 psig).

Flow adjustment limits the maximum flow rate to between approx. 20 and 100%.

Adjustment of the start gas rate: 0 to approx. 70%.

Opening times:

VAS../N quick opening: < 1 s;

VAS../L slow opening: up to max. 10 s.

Closing time:

VAS../N, VAS../L quick closing: < 1 s.

Switching frequency:

VAS../N: any, max. 30 x per minute.

VAS../L: max. 2 x per minute. There should be a period of 20 seconds between switching off and on again so that the damping is fully effective.

Safety valve:

Class A, Group 2 pursuant to EN 13611 and EN 161,

Factory Mutual (FM) Research Class: 7400 and 7411,

ANSI Z21.21 and CSA 6.5.

Valve housing: aluminium, valve seal: NBR.

Connection flanges:

up to size 3: Rp internal thread to ISO 7-1, NPT to ANSI/ASME;

size 2 and higher: with PN 16 ISO flange (pursuant to ISO 7005),

size 6 and higher: with ANSI flange pursuant to ANSI 150.

Cable gland: M20 x 1.5.

Electrical connection: cable with max. 2.5 mm² (AWG 12) or plug with socket to EN 175301-803. Duty cycle: 100%.

Power factor of the solenoid coil: $\cos \varphi = 0.9$.

12.2.1 Recommended tightening torque

Side mounting	Tightening torque
Screw plug G 1/4" (1/4" NPT)	18 ± 1 Nm (159 lb")
Test nipple G 1/4" (1/4" NPT)	18 ± 1 Nm (159 lb")
Cylinder screw M5 bypass VAS 1	5 ± 0.4 Nm (44.3 ± 3.5 lb")
Cylinder screw M5 adapter plate	4.5 ± 0.3 Nm (39.8 ± 2.7 lb")
Cylinder screw M4 pressure switch, TC, TC adapter	2.5 ± 0.2 Nm (22.1 ± 1.8 lb")
Cover screw DG..C	0.45 Nm (4 lb")
Socket DG..C	0.45 Nm (4 lb")

12.3 Electrical data for VAS 6-9/VCS 6-9

Mains voltage for VAS 6-8/VCS 6-8:

120 V AC, +10/-15%, 50/60 Hz,

230 V AC, +10/-15%, 50/60 Hz,

24 V DC, ±20%.

Mains voltage for VAS 9/VCS 9:

120-230 V AC, +10/-15%, 50/60 Hz.

Switching frequency: max. 1 x per minute.

Max. temperature of solenoid coil:

+20°C (+68°F) above ambient temperature.

Current consumption at 20°C (68°F):

Pick-up current: 1.8 A,

holding current: 0.3 A.

Power consumption:

Type	Voltage	Power
VAS 6	24 V DC	70 W
VAS 6	120 V AC	63 W
VAS 6	230 V AC	63 W
VAS 7	24 V DC	75 W
VAS 7	120 V AC	90 W
VAS 7	230 V AC	83 W
VAS 8	24 V DC	99 W
VAS 8	120 V AC	117 W
VAS 8	230 V AC	113 W
VAS 9	24 V DC	-
VAS 9	120 V AC	200 (15*) W
VAS 9	230 V AC	200 (15*) W
VCS 6	24 V DC	140 W
VCS 6	120 V AC	126 W
VCS 6	230 V AC	126 W
VCS 7	24 V DC	150 W
VCS 7	120 V AC	180 W

Type	Voltage	Power
VCS 7	230 V AC	166 W
VCS 8	24 V DC	198 W
VCS 8	120 V AC	234 W
VCS 8	230 V AC	226 W
VCS 9	24 V DC	-
VCS 9	120 V AC	400 (30*) W
VCS 9	230 V AC	400 (30*) W

* After opening.

Contact rating of proof of closure switch:

Type	Voltage	Current (resistive load)	
		min.	max.
VAS..S, VCS..S	12-250 V AC, 50/60 Hz	100 mA	3 A
VAS..G, VCS..G	12-30 V DC	2 mA	0.1 A

Switching frequency of proof of closure switch: max. 5 x per minute.

Switching current	Switching cycles*	
	$\cos \varphi = 1$	$\cos \varphi = 0.6$
0.1	500,000	500,000
0.5	300,000	250,000
1	200,000	100,000
3	100,000	-

* Limited to max. 200,000 cycles for heating systems.

12.4 Air flow rate Q

Air flow rate Q for a pressure loss of $\Delta p = 1$ mbar (0,4 "WC):

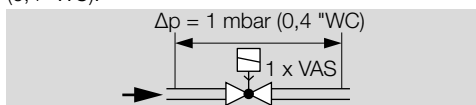

	Air flow rate	
	Q [m ³ /h]	Q [SCFH]
VAS 6	66	2330
VAS 7	95	3354
VAS 8	144	5084
VAS 9	215	7590
VAS 6	52	1835
VAS 7	74	2610
VAS 8	111	3919
VAS 9	165	5825

12.5 Flow rate, VAS 1 attached to VAS 6–9, VCS 6–9

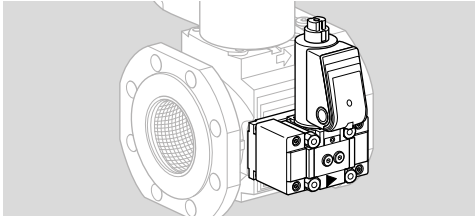

The adjusting range for the bypass valve, and pilot gas valve, VAS 1 was determined using the values measured for open flow adjustment (Q_{max}) and fully reduced flow adjustment (Q_{min}).

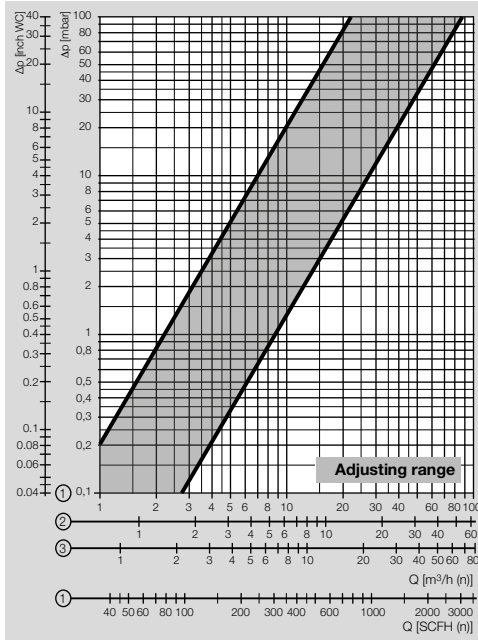

- 1 = natural gas ($\rho = 0.80 \text{ kg/m}^3$)
- 2 = propane ($\rho = 2.01 \text{ kg/m}^3$)
- 3 = air ($\rho = 1.29 \text{ kg/m}^3$)

13 DESIGNED LIFETIME

This information on the designed lifetime is based on using the product in accordance with these operating instructions. Once the designed lifetime has been reached, safety-relevant products must be replaced.

Designed lifetime (based on date of manufacture) in accordance with EN 13611, EN 161 for VAS, VCS:

Type	Designed lifetime	
	Switching cycles	Time (years)
VAS 110 to 225	500,000	10
VAS 232 to 365	200,000	10
VAS/VCS 665 to 780	100,000	10
VAS/VCS 8100 to 9125	50,000	10

You can find further explanations in the applicable rules and regulations and on the afecor website (www.afecor.org).

This procedure applies to heating systems. For thermoprocessing equipment, observe local regulations.

14 LOGISTICS

Transport

Protect the unit from external forces (blows, shocks, vibration).

Transport temperature: see page 9 (12.1 Ambient conditions).

Transport is subject to the ambient conditions described.

Report any transport damage on the unit or packaging without delay.

Check that the delivery is complete.

Storage

Storage temperature: see page 9 (12.1 Ambient conditions).

Storage is subject to the ambient conditions described.

Storage time: 6 months in the original packaging before using for the first time. If stored for longer than this, the overall service life will be reduced by the corresponding amount of extra storage time.

Packaging

The packaging material is to be disposed of in accordance with local regulations.

Disposal

Components are to be disposed of separately in accordance with local regulations.

15 CERTIFICATION

15.1 Certificate download

Certificates – see www.docuthek.com

15.1.1 Declaration of conformity



We, the manufacturer, hereby declare that the products VAS/VCS 6–9 with product ID No. CE-0063BR1310 comply with the requirements of the listed Directives and Standards.

Directives:

- 2014/35/EU – LVD
- 2014/30/EU – EMC
- 2011/65/EU – RoHS II
- 2015/863/EU – RoHS III

Regulation:

- (EU) 2016/426 – GAR

Standards:

- EN 161:2022

The relevant product corresponds to the tested type sample.

The production is subject to the surveillance procedure pursuant to Regulation (EU) 2016/426 Annex III paragraph 3.

Elster GmbH

15.1.2 SIL and PL



See Safety manual/Technical Information VAS, VCS (D, GB, F) – Safety-specific characteristic values.

15.1.3 UKCA certified



Gas Appliances (Product Safety and Metrology etc. (Amendment etc.) (EU Exit) Regulations 2019)

BS EN 161:2011+A3:2013

BS EN 13611:2015

15.1.4 FM listed

Approval does not apply for 100 V AC and 200 V AC.



Factory Mutual (FM) Research Class: 7400 and 7411 Safety overpressure slam shut valves. Designed for applications pursuant to NFPA 85 and NFPA 86.

15.1.5 ANSI/CSA approved

Approval does not apply for 100 V AC and 200 V AC.



Canadian Standards Association – ANSI Z21.21 and CSA 6.5

15.1.6 UL listed (120 V AC)



Underwriters Laboratories – UL 429 “Electrically operated valves”.

15.1.7 AGA listed

Approval does not apply for 100 V AC and 200 V AC.



Australian Gas Association, Approval No.: 3968.

15.1.8 Eurasian Customs Union



The products VAS 6-9 meet the technical specifications of the Eurasian Customs Union.

15.1.9 REACH Regulation

The device contains substances of very high concern which are listed in the Candidate List of the European REACH Regulation No. 1907/2006. See Reach list HTS at www.docuthek.com.

15.1.10 China RoHS

Directive on the restriction of the use of hazardous substances (RoHS) in China. Scan of the Disclosure Table China RoHS2, see certificates at www.docuthek.com.

16 PRESSURE UNITS

mbar	Pa	kPa	"WC
1	100	0.1	0.4

FOR MORE INFORMATION

The Honeywell Thermal Solutions family of products includes Honeywell Combustion Safety, Eclipse, Exothermics, Hauck, Kromschroder and Maxon. To learn more about our products, visit ThermalSolutions.honeywell.com or contact your Honeywell Sales Engineer.

Elster GmbH
Strotheweg 1, D-49504 Lotte
T +49 541 1214-0
hts.lotte@honeywell.com
www.kromschroeder.com

Global centralized service deployment coordination:
T +49 541 1214-365 or -555
hts.service.germany@honeywell.com

Translation from the German
© 2024 Elster GmbH

Honeywell
kromschroder